

Concepts

Products

Service

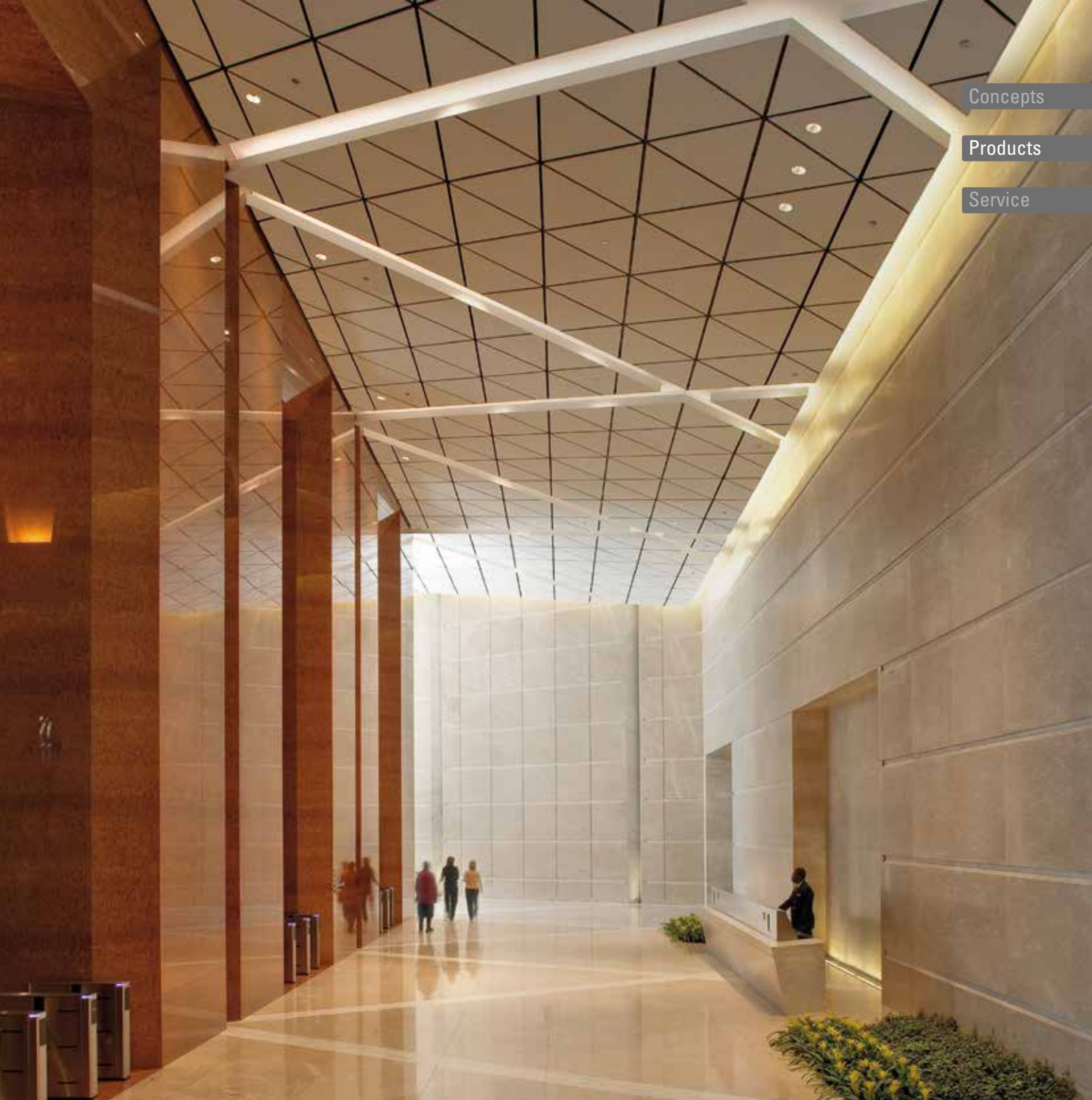

Appearance Counts. Function Too.

Lindner Hook-On/Corridor Ceilings and
Plafotherm® Heated and Chilled Hook-On Ceilings



Lindner

Building New Solutions

Building new solutions.

Lindner undertakes major worldwide projects in all areas of interior finishes, insulation technology, industrial services and building facades. From pre-planning through to project completion Lindner is your partner of choice.

The Company's extensive manufacturing capability enables quality to be strictly maintained whilst allowing maximum flexibility to meet individual project requirements.

Environmental considerations are fundamental to all Lindner's business principles.

Through partnerships with clients Lindner turns concepts into reality.

Choosing Lindner you have:

Lindner Concepts:
Tailored solutions specifically geared to satisfy individual project requirements

Lindner Products:
Quality materials and systems to the very highest industry standards

Lindner Service:
Comprehensive project management services

Lindner Hook-On/ Corridor Ceilings

Fit every space.

Lindner Hook-On and Corridor ceilings are multipurpose ceiling solutions. Widely adaptable, both functionally and visually, they can span up to 3,300 mm in rooms and corridors without the need for additional suspension. Service installations in the ceiling cavity can be easily accessed. All ceiling systems are fitted with Lindner Lighting Systems from our own production. Lindner Heating and Cooling Technologies are available as an option.

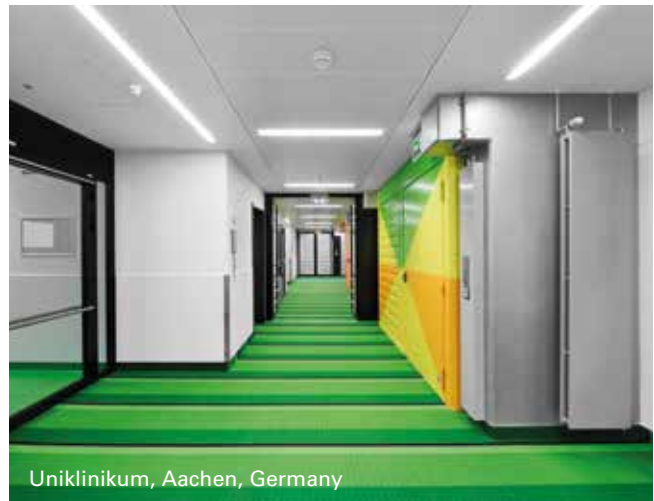

Customer benefits at a glance

- A range of ceiling panel shapes, such as rectangular, square, trapezoidal, triangular as well as curved
- Easily accessible
- Wide selection of surface options
- Perfectly integrated Lindner Lighting Solutions
- Pleasant temperature levels with our Plafotherm® Heating and Cooling Technologies

Content

LMD Hook-On Ceilings	
LMD-E 200	8
LMD-E 210	9
LMD-E 213	10
LMD-E 213 WL	11
LMD-E 214	12
LMD Corridor Ceilings	
LMD-E 300	15
LMD-E 312	16
LMD-E 321	17
LMD-E 340	18
Sound absorption	19
Building material class	19
Plafotherm® Heated/Chilled Hook-On Ceilings	
Heating and Cooling	23
Building material class	24
Sound absorption	25
Hydraulic Components	26
Lindner Lighting systems	27
Joint Designs	28
Wall Connections	29
Surfaces	30
Green Building	31

LMD Hook-On Ceilings

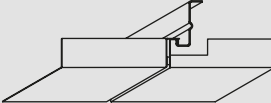
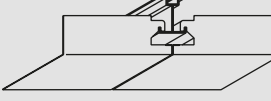
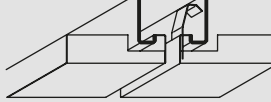
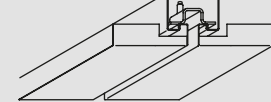
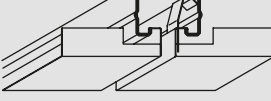
System			Page
LMD-E 200		Hook-On Ceiling Concealed supporting profiles, removable panels	8
LMD-E 210		Hook-On Ceiling with butt joints Concealed supporting profiles, removable panels	9
LMD-E 213		Hook-On Ceiling with accentuated joints Concealed Hook-On substructure with accentuated joints, removable panels with Swing-Down option	10
LMD-E 213 WL		Hook-On Ceiling for exterior areas Concealed Hook-On substructure with accentuated joints, removable panels with Swing-Down option	11
LMD-E 214		Hook-On Ceiling with open joints Concealed supporting profiles, removable panels with Swing-Down option	12



Office building Moscow, Russia
© Zahar Aborkin

Tested quality



Building material class A2-s1, d0
tested to EN 13501-1
Class A (IBC) tested to ASTM E 84
Class 0 tested to BS 476 part 6/7



Light reflectance approx. 82 %
9010 acc. to Lindner,
unperforated tested to DIN 5033



Sound absorption
up to sound absorption class A
tested to ISO 11654



Durability
exposure class A
tested to EN 13964, table 8 and 9



Environmental product declarations
validated to ISO 14025

Certification / Regulations



Execution of the system ceilings
tested to EN 13964



Quality standard according to the technical
regulations of TAIM (Association of Industrial
Metal Ceiling Manufacturers TAIM e.V.)

Technical data

Metal ceiling system	
Ceiling panel	Length up to 3,300 mm, width up to 1,250 mm, made of zinc-galvanised steel, powder-coated, aluminium or stainless steel available on request, depending on the system
Edges	square
Perforation	available in all standard perforations depending on panel dimensions resp. material, see Surface Brochure
Surface	electrostatically applied powder-coating further surfaces see Surface Brochure
Colour	9010 acc. to Lindner, other colors in RAL and NCS available
Substructure	Profile manufactured from galvanised sheet steel, roll-formed or bent steel profile including suspension
Relevant norms	DIN EN 10152/10327/13964, DIN EN ISO 12944, BS 2989, ASTM A 653

LMD-E 200

Infinite Versatility.

Hook-On Ceiling – Concealed supporting profiles, removable panels

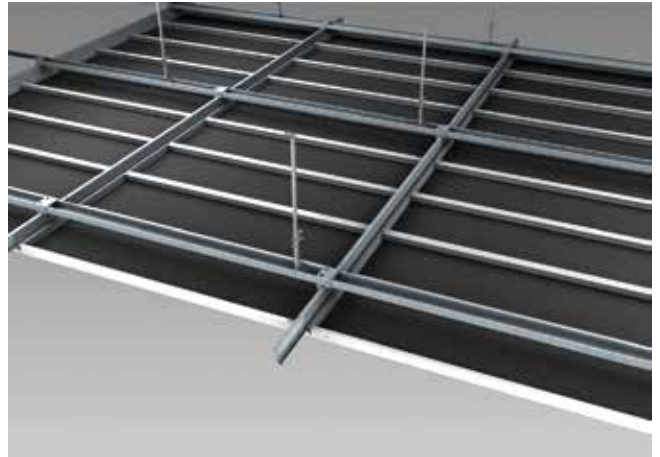
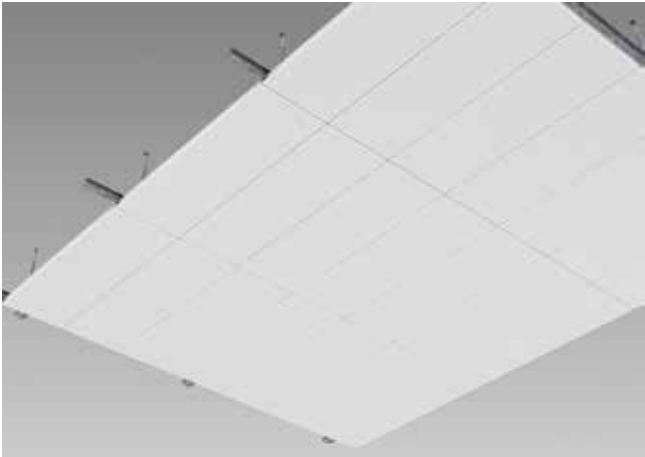

LMD-E 200 is the 'all-rounder' within this range. Its strong points are: tightly abutting panels for closed

joints, high quality metal panel, appealing visual and ease of installation.

Standard requirements

System	Detail	Installation detail
<p>LMD-E 200 Type 2 Hook-On/Lay-On length up to 3,000 mm, width up to 1,250 mm</p>		
<p>LMD-E 200 Type 3 Hook-On/Lay-On self-aligning length up to 3,000 mm, width up to 1,250 mm</p>		
<p>LMD-E 200 Type 4 Hook-On on both sides length up to 3,000 mm, width up to 1,250 mm</p>		
<p>LMD-E 200 Type 5 Cassette Hook-On/Lay-On 600 mm x 600 mm 625 mm x 625 mm</p>		

LMD-E 210

Cleverly designed.

Hook-On Ceiling with butt joints – Concealed supporting profiles, removable panels

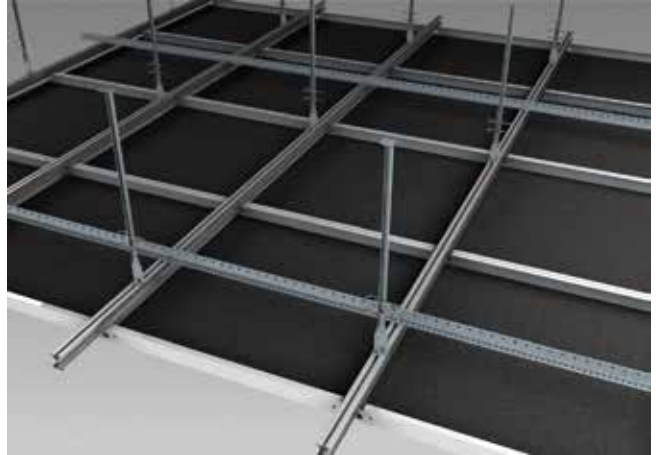
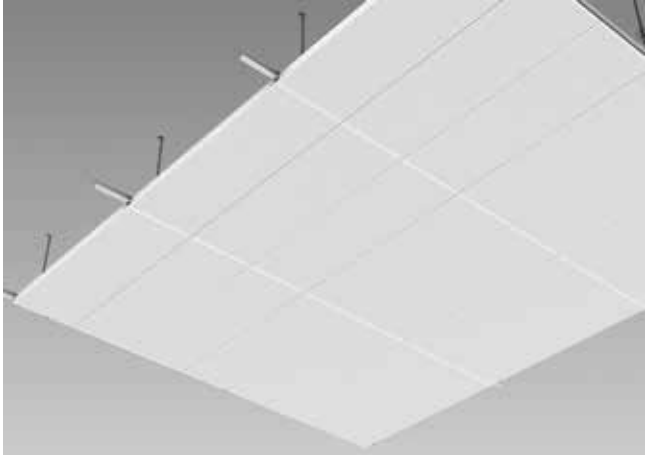

The substructure for LMD-E 210 makes installation easy. The design of the short sides of the panel and the construction of the profile automatically ensure

joint alignment during installation. All panels can be removed without the need for any tools.

Standard requirements

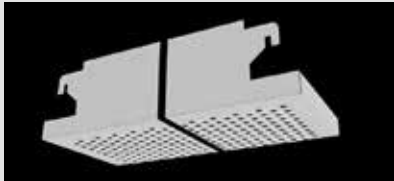
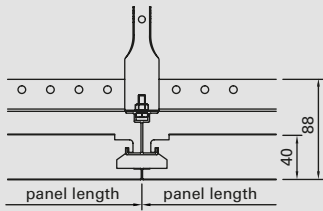
System	Detail	Installation detail
LMD-E 210 Type 1 Hook-On length up to 3,000 mm width up to 625 mm		 <p>Technical drawing showing the installation detail of the LMD-E 210 panel. The drawing illustrates the panel's connection to the supporting profile. Key dimensions are indicated: a vertical dimension of 88 mm for the total height of the panel and profile assembly, and a vertical dimension of 40 mm for the height of the supporting profile. The horizontal dimension is labeled as 'panel length'.</p>

LMD-E 213

Views welcome.

Hook-On Ceiling with accentuated joints – Concealed Hook-On substructure with accentuated joints, removable panels optionally with Swing-Down/Slide function

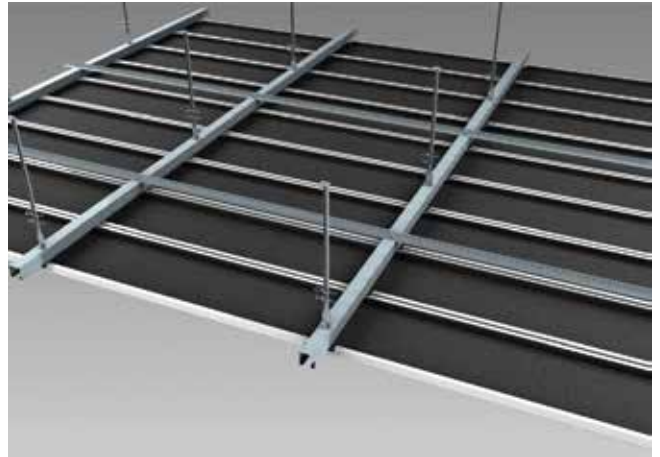
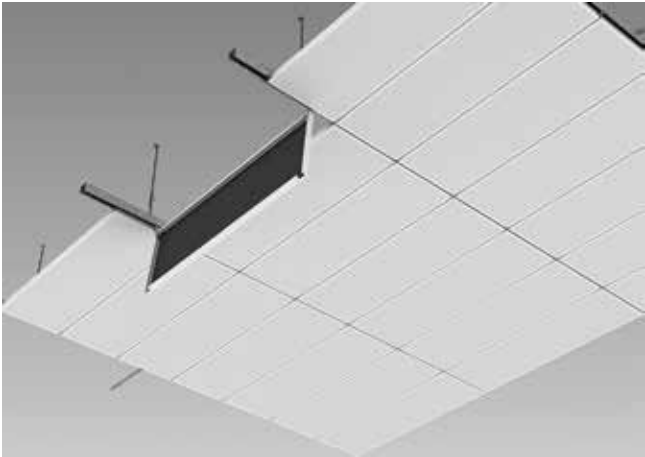

LMD-E 213's hook-on profile defines its appearance. The emphasised joints are available in widths of

10 mm, 15 mm or 20 mm. Removable and Swing-Down panels can be combined.

Standard requirements

System	Detail	Installation detail
<p>LMD-E 213 Type 1 Hook-On length up to 3,000 mm, width up to 1,250 mm</p>		
<p>LMD-E 213 Type 2 Hook-On with Swing-Down option < 1.2 m² length up to 2,500 mm, width up to 1,250 mm</p>		
<p>LMD-E 213 Type 3 Hook-On with Swing-Down option > 1.2 m² length up to 3,000 mm, width up to 1,250 mm</p>		

LMD-E 213 WL

Safe under any conditions.

Hook-On Ceiling for exterior areas – Concealed Hook-On substructure with accentuated joints, removable panels with Swing-Down option

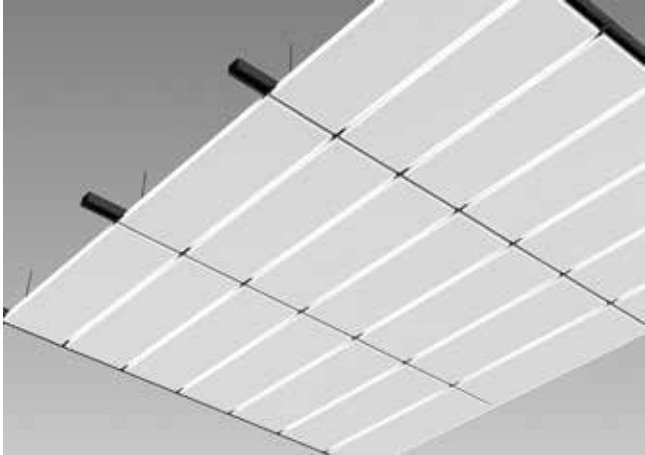

The Hook-On ceiling LMD-E 213 WL is suitable for roofed outdoor areas for wind pressure and suction loads up to 100 kg/m² in standard execution.

The exterior ceiling in steel or stainless steel is fast and easy to install. Moreover, it is furnished with a high-grade Meteo corrosion protection coating.

Standard requirements

System	Detail	Installation detail
<p>LMD-E 213 WL Type 1 Hook-On length up to 2,000 mm width up to 1,000 mm</p>		
<p>LMD-E 213 WL Type 2 Hook-On with Swing-Down option length up to 2,000 mm width up to 1,000 mm</p>		

LMD-E 214

Expert expertise.

Hook-On Ceiling with open joints – Concealed Hook-On substructure with Swing-Down option, removable panels

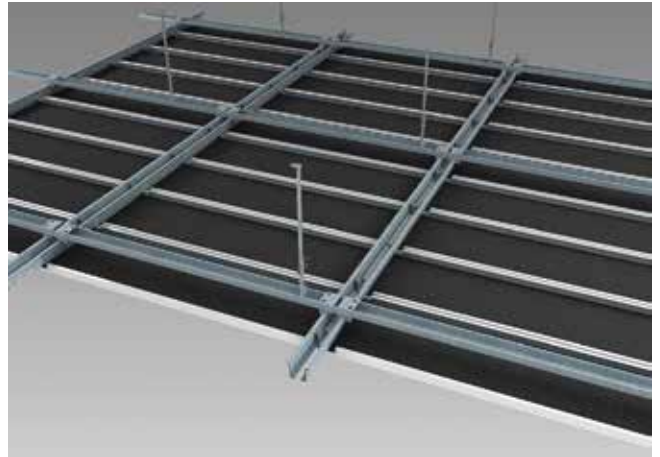
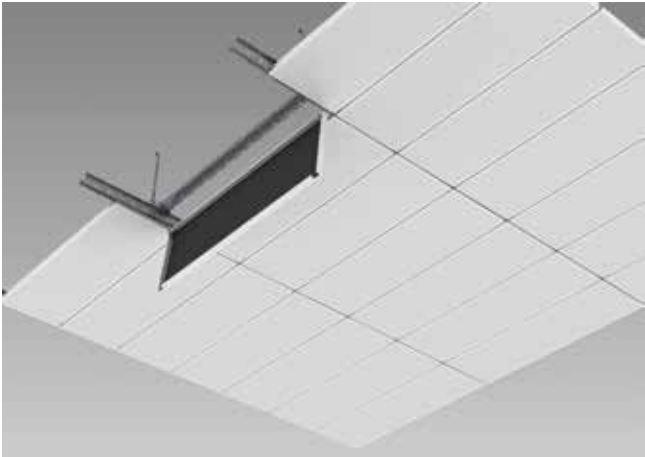

The LMD-E 214 system is a direct result of Lindner's on-site experience: quickly installed and easily

accessed with an outstanding visual. Joint widths are variable exceeding 10 mm.

Standard requirements

System	Detail	Installation detail
<p>LMD-E 214 Type 1 Hook-On length up to 3,000 mm, width up to 1,250 mm</p>		
<p>LMD-E 214 Type 2 Hook-On with Swing-Down option < 1.2 m² length up to 2,500 mm, width up to 1,250 mm</p>		
<p>LMD-E 214 Type 3 Hook-On with Swing-Down option > 1.2 m² length up to 3,000 mm, width up to 1,250 mm</p>		



Canberra Airport, Australia

LMD Corridor Ceilings

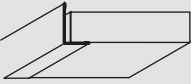
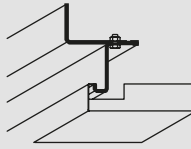
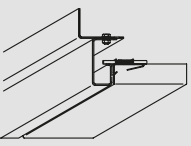
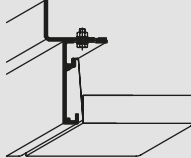
System			Page
LMD-E 300		Lay-In Corridor Ceiling Wall connection profile visible, panels removable	15
LMD-E 312		Hook-On Corridor Ceiling Concealed Hook-On substructure, removable panels with Swing-Down option	16
LMD-E 321		Lay-In/Swing-Down Corridor Ceiling Wall connection profile visible, Swing-Down-and-Slide panels	17
LMD-E 340		Drop-Slide Corridor Ceiling Wall connection profile visible, Drop-Slide panels	18

LMD-E 300

Simplicity at its best.

Lay-In Corridor Ceiling – Wall connection profile visible, panels removable

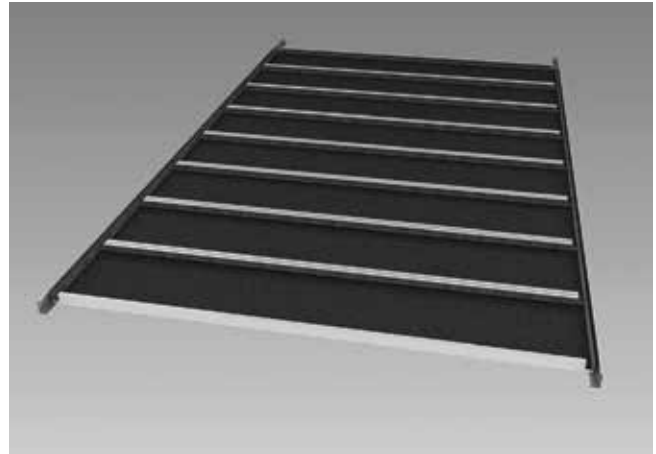
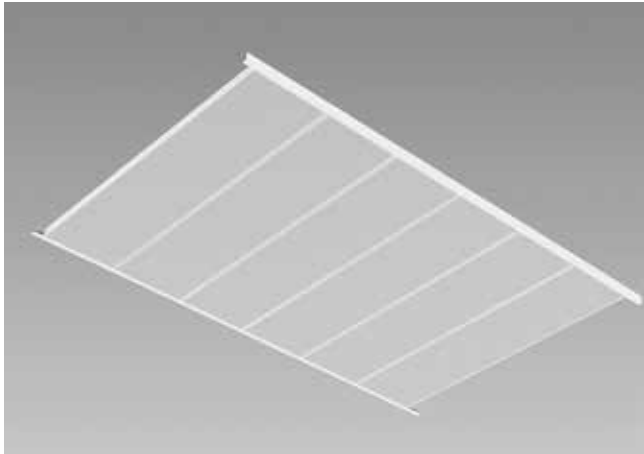

LMD-E 300 spans corridors of up to 3,000 mm with maximum efficiency: wall connection profiles on

each side of the corridor are installed to carry Lay-In metal ceiling panels.

Standard requirements

System	Detail	Installation detail
<p>LMD-E 300 Type 1 Lay-In length up to 3,000 mm, width up to 1,250 mm</p>		<p>L-perimeter trim</p> <p>shadow gap trim</p>

LMD-E 312

With an optional swing.

Hook-On Corridor Ceiling – Concealed Hook-On substructure, removable panels optionally with Swing-Down/Slide function

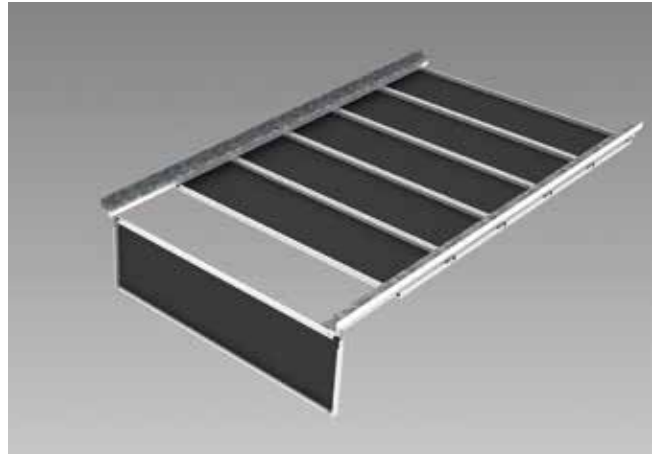
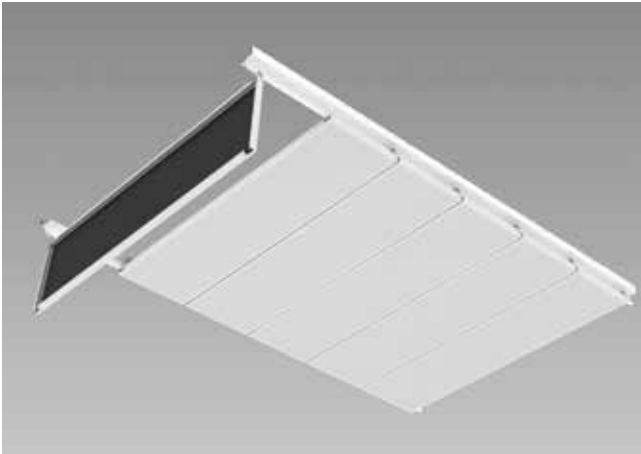

Swing-Down access panels are an option with LMD-E 312. We leave it to you to combine them with removable hook-on panels. In both cases the

substructure is hidden in a shadow gap connected to the wall.

Standard requirements

System	Detail	Installation detail
<p>LMD-E 312 Type 1 Hook-On length up to 3,000 mm, width up to 1,250 mm</p>		
<p>LMD-E 312 Type 2 Hook-On with Swing-Down option < 1.2 m² length up to 2,500 mm, width up to 1,250 mm</p>		
<p>LMD-E 312 Type 3 Hook-On with Swing-Down option > 1.2 m² length up to 3,000 mm, width up to 1,250 mm</p>		

LMD-E 321

Never loses its swing.

Lay-In/Swing-Down Corridor Ceiling – Wall connection profile visible, Swing-Down/Slide panels

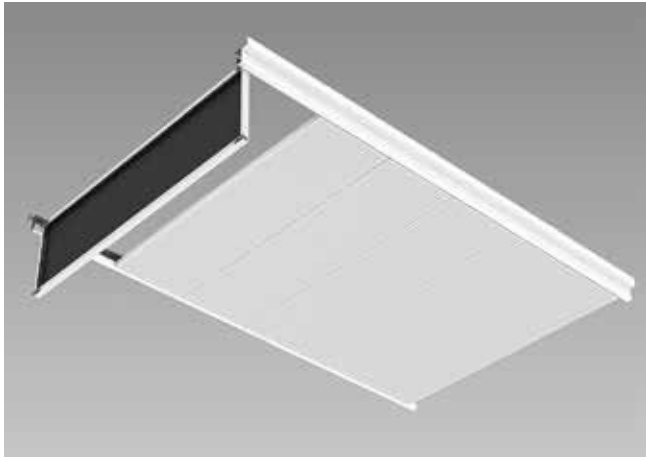

LMD-E 321 provides comfortable access to the ceiling cavity: the durable Swing-Down mechanism allows access through every panel. Furthermore the slide option provides a larger opening.

Hinging and locking elements are protected by DBGM.



Standard requirements

System	Detail	Installation detail
<p>LMD-E 321 Type 1 Swing-Down option on longitudinal side length up to 3,000 mm, width up to 1,250 mm</p>		
<p>LMD-E 321 Type 2 Swing-Down option on short side length up to 2,200 mm, width up to 1,250 mm</p>		

LMD-E 340

As good as it gets.

Drop-Slide Corridor Ceiling – Wall connection profile visible, Drop-Slide panels

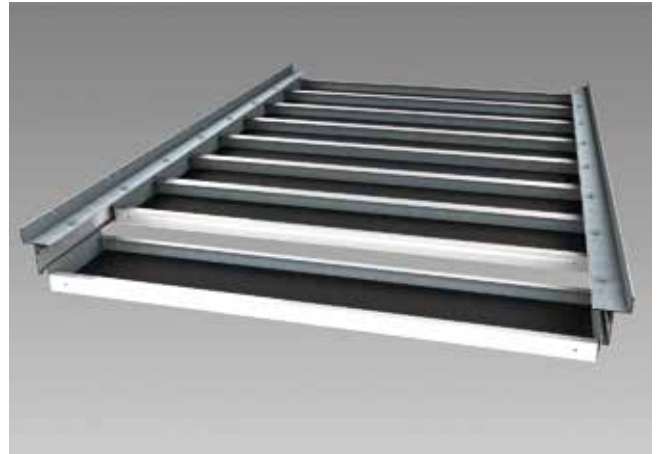
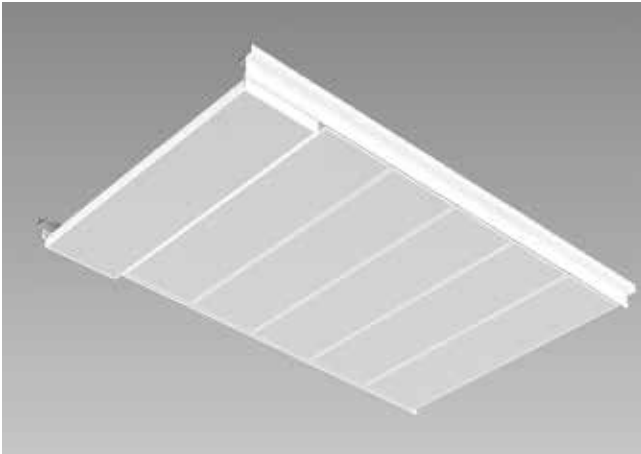

Lindner's patented Drop-Slide ceiling is the pick of the bunch! Each panel can be lowered and slid in either direction, providing convenient access to service installations in the void.

System is protected by EP/DBP and DBGM.



Standard requirements

System	Detail	Installation detail
LMD-E 340 Type 1 Drop-Slide length up to 3,000 mm, width up to 800 mm		



Sound absorption

Example of the range of standard perforations available for ceilings **without** Heating and Cooling Technology

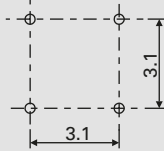
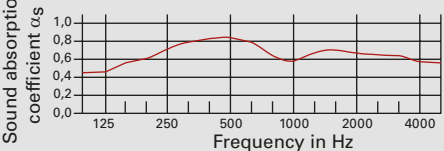
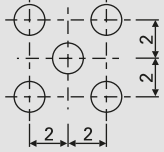
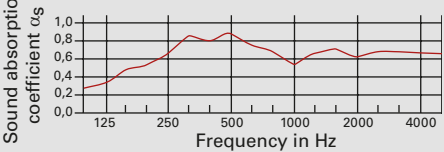
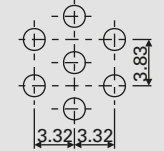
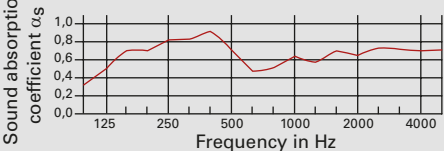
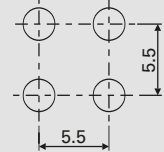
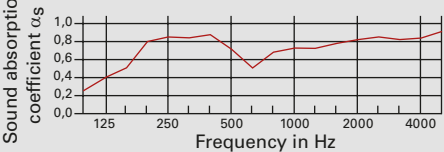
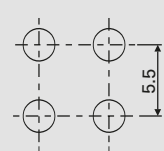
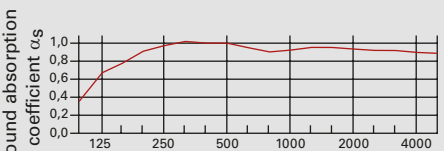
<p>Rg 0,7 - 4 Hole diameter 0.7 mm open area 4 % valid for steel 0.6 mm acoustic tissue</p>		<p>$\alpha_w = 0.70$ SAA / $\alpha_{s,m} = 0.71$ NRC = 0.70</p>	
<p>Rd 1,6 - 25 Hole diameter 1.6 mm open area 25 % valid for steel 0.6 mm acoustic tissue</p>		<p>$\alpha_w = 0.70$ SAA / $\alpha_{s,m} = 0.70$ NRC = 0.70</p>	
<p>Rv 1,8 - 20 Hole diameter 1.8 mm open area 20 % valid for steel 0.6 mm acoustic tissue</p>		<p>$\alpha_w = 0.75 (L)$ SAA / $\alpha_{s,m} = 0.73$ NRC = 0.75</p>	
<p>Rg 2,5 - 16 Hole diameter 2.5 mm open area 16 % valid for steel 0.6 mm acoustic tissue</p>		<p>$\alpha_w = 0.75 (L)$ SAA / $\alpha_{s,m} = 0.75$ NRC = 0.75</p>	
<p>Rg 2,5 - 16 Hole diameter 2.5 mm open area 16 % valid for steel 0.6 mm acoustic tissue and Sound absorption inlay</p>		<p>$\alpha_w = 1,0 (L)$ SAA / $\alpha_{s,m} = 0.92$ NRC = 0.95</p>	

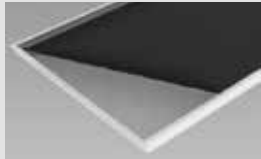
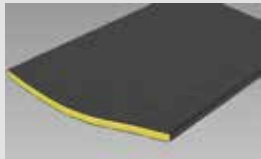

Building material class

Product	Building material class	
<p>Metal ceiling panel Metal ceiling panel manufactured from galvanized sheet steel, including powder-coated surface in colour 9010 acc. to Lindner and bonded acoustic tissue on the reverse side</p>	<p>A2-s1, d0 tested to EN 13501-1</p> 	
<p>Mineral wool inlay Mineral wool shrink-wrapped in acoustic transparent foil Insula A2 Insula I Insula Basic</p>	<p>A2-s1, d0 tested to EN 13501-1 B1 tested to DIN 4102-1 B2 tested to DIN 4102-1</p> 	



Office and practice building, Leutkirch im Allgäu, Germany

Plafotherm® Heated/Chilled Hook-On Ceilings

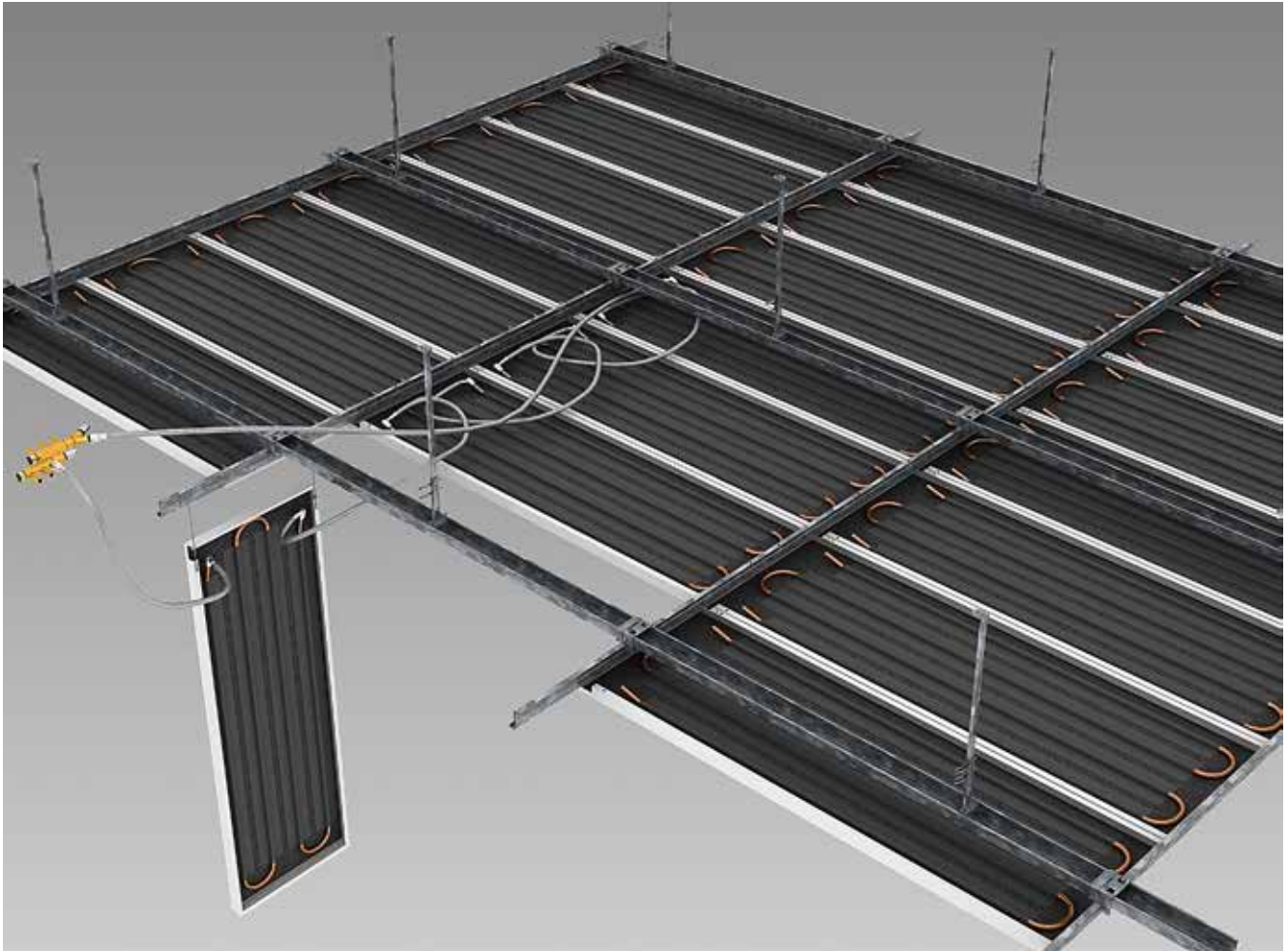

The integrated Heating and Cooling Technologies of Plafotherm® E create a pleasant temperature for any living and working environment. The tried and tested Hook-On system ensures safe handling. We will be glad to give your metal ceiling a distinctive look by applying one of our many eye-catching Lindner surfaces.

Technology and development centre
Groz Beckert, Albstadt, Germany

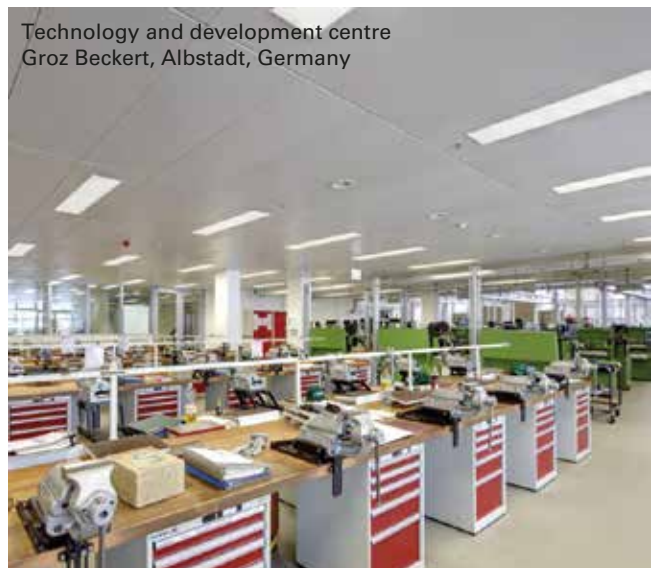

Programme

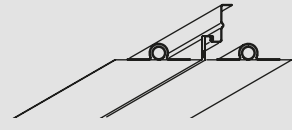
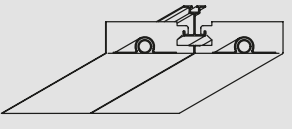
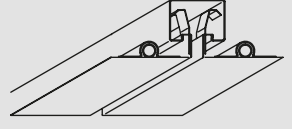
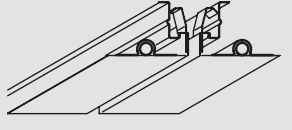
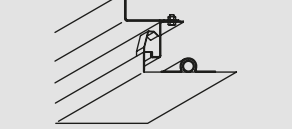
System	Detail	Description
Plafotherm® E 200		Hook-On Heated and Chilled Ceiling Concealed supporting profiles, panels removable
Plafotherm® E 210		Hook-On Heated and Chilled Ceiling with butt joints Concealed supporting profiles, panels removable
Plafotherm® E 213		Hook-On Heated and Chilled Ceiling with accentuated joints Concealed Hook-On substructure with accentuated joints, removable panels with Swing-Down option
Plafotherm® E 214		Hook-On Heated and Chilled Ceiling with open joints Concealed supporting profiles, removable panels with Swing-Down option
Plafotherm® E 312		Heated and Chilled Corridor Hook-On ceiling Concealed Hook-On substructure, removable panels with Swing-Down option

Tested quality



Building material class A2-s2, d0 tested to EN 13501-1



Light reflectance approx. 82 %
9010 acc. to Lindner,
unperforated tested to DIN 5033



Sound absorption
up to sound absorption class B
tested to ISO 11654



Durability
exposure class A
tested to EN 13964, table 8 and 9



Environmental product declarations
validated to ISO 14025



Nominal cooling capacity up to 120 W/m²
tested to DIN EN 14240 (10 K)
Nominal heating capacity up to 133 W/m²
tested to DIN EN 14037 (15 K)

Certification / Regulations



Execution of the system ceilings
tested to EN 13964



Quality standard according to the technical
regulations of TAIM (Association of Industrial
Metal Ceiling Manufacturers TAIM e.V.)



Heating and Cooling

Heat conducting profile with Cu-pipe fret

Heating/Cooling technology	consisting of aluminium heat conducting profile with copper pipe fret, integrated into ceiling panel for thermal conductivity
Heat conducting profile	aluminium profile plain or perforated, standard widths of 80 and 120 mm
Pipe fret	copper coil, 12 x 0.5 mm or 12 x 0.75 mm
Water volume	approx. 1 l/m ²
Centre distance	from 90 mm on
Nominal cooling capacity acc. to DIN EN 14240 (10K)	112 W/m ²
Nominal heating capacity acc. to DIN EN 14037 (15K)	126 W/m ²

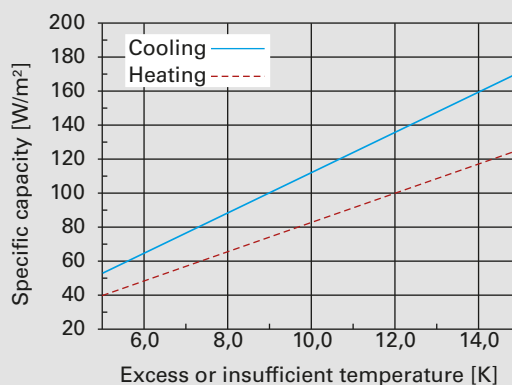

Heat conducting profile with stainless pipe fret

Heating/Cooling technology	consisting of aluminium heat conducting profile with stainless steel pipe fret, integrated into ceiling panel for thermal conductivity
Heat conducting profile	aluminium profile plain or perforated, standard widths of 80 and 120 mm
Pipe fret	stainless, 12 x 0.5 mm
Water volume	approx. 1 l/m ²
Centre distance	from 90 mm on
Nominal cooling capacity acc. to DIN EN 14240 (10K)	109 W/m ²
Nominal heating capacity acc. to DIN EN 14037 (15K)	123 W/m ²

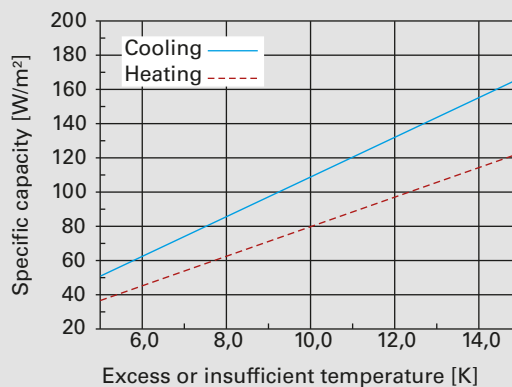

Graphite panel with Cu-pipe fret

Heating/Cooling technology	consisting of graphite panel with copper pipe fret, integrated into ceiling panel for thermal conductivity
Heat conducting profile	heat conducting graphite panel plain
Pipe fret	copper coil, 12 x 0.5 mm
Water volume	approx. 1 l/m ²
Centre distance	100 mm
Nominal cooling capacity acc. to DIN EN 14240 (10K)	120 W/m ²
Nominal heating capacity acc. to DIN EN 14037 (15K)	133 W/m ²

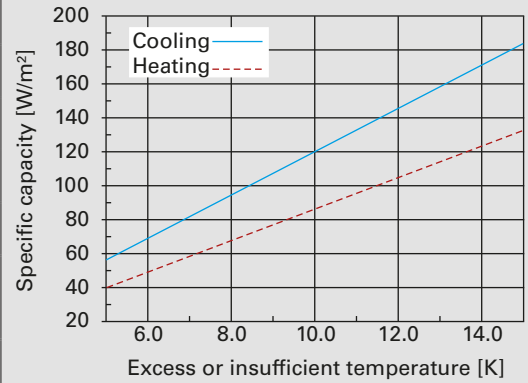

Determination of excess and insufficient temperature

$$\Delta T_K = \vartheta_R - \frac{\vartheta_{VL} + \vartheta_{RL}}{2}$$

$$\Delta T_H = \frac{\vartheta_{VL} + \vartheta_{RL}}{2} - \vartheta_R$$

ΔT_K = insufficient temperature (cooling) [K]

ΔT_H = excess temperature (heating) [K]

ϑ_R = room temperature [C°]

ϑ_{VL} = flow temperature [C°]

ϑ_{RL} = return-flow temperature [C°]

Recommended operation data

Flow temperature (cooling)	15 - 17 °C
Temperature spread	2 - 4 K
Flow temperature (heating)	30 - 35 °C
Temperature spread	4 - 6 K
Recommended pressure drops	25 - 30 kPa

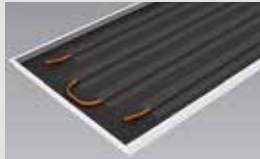
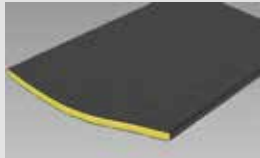

Building material class

Product	Building material class	
Plafotherm® metal ceiling panel Metal ceiling panel manufactured from galvanized sheet steel, including powder-coated surface in colour 9010 acc. to Lindner, bonded acoustic tissue on the reverse side and heat conducting profile	A2-s2, d0 tested to EN 13501-1	
Insula Mineral wool inlay Mineral wool shrink-wrapped in acoustic transparent foil Insula A2 Insula I Insula Basic	A2-s1, d0 tested to EN 13501-1 B1 tested to DIN 4102-1 B2 tested to DIN 4102-1	



Sound absorption

Example of possible standard perforations for Heated and Chilled Ceilings with heat conducting profiles

Standard heat conducting profile

<p>Rv 2,0 - 20 hole diameter 2.0 mm open area 20 % heat conducting profile acoustic tissue mineral wool lining</p>		<p>$\alpha_w = 0.55$ (LM) $SAA / \alpha_{s,m} = 0.69$ $NRC = 0.70$</p>	
<p>Rg 2,5 - 16 hole diameter 2.5 mm open area 16 % heat conducting profile acoustic tissue mineral wool lining</p>		<p>$\alpha_w = 0.50$ (L) $SAA / \alpha_{s,m} = 0.64$ $NRC = 0.65$</p>	

Acoustically effective heat conducting profile

<p>Rv 1,8 - 20 hole diameter 1.8 mm open area 20 % acoustically effective heat conducting profile acoustic tissue mineral wool lining</p>		<p>$\alpha_w = 0.80$ $SAA / \alpha_{s,m} = 0.79$ $NRC = 0.80$</p>	
<p>Rv 1,8 - 20 hole diameter 1.8 mm open area 20 % acoustically effective heat conducting profile acoustic tissue</p>		<p>$\alpha_w = 0.70$ (L) $SAA / \alpha_{s,m} = 0.74$ $NRC = 0.75$</p>	

Hydraulic Components

For perfect connections.

For perfect heating and cooling connections, Lindner provides a great number of hydraulic components and accessory parts.

Advantages:

- Tested system
- One-stop solutions
- Ideal for heating/cooling systems
- Maintained independently from other building trades

Connection hoses and fittings

High-grade steel hoses are oxygen impermeable, tested to DIN 4726, and are used as connection hoses. These hoses are perfectly suited to accept a large number of fittings. The quick plug connector MultiQuickConnect does without retaining claws which unnecessarily damage the meanders. Thus, a quick and user-friendly installation and removal is ensured. A locking button that clearly sticks out checks the correct installation and guarantees a positive connection and a secure hold. A system distributor with three outgoing lines completes the system.



Lindner Lighting Systems

Integration is our passion.

Lindner has a wide range of lighting fixtures that fulfill even the most demanding requirements.

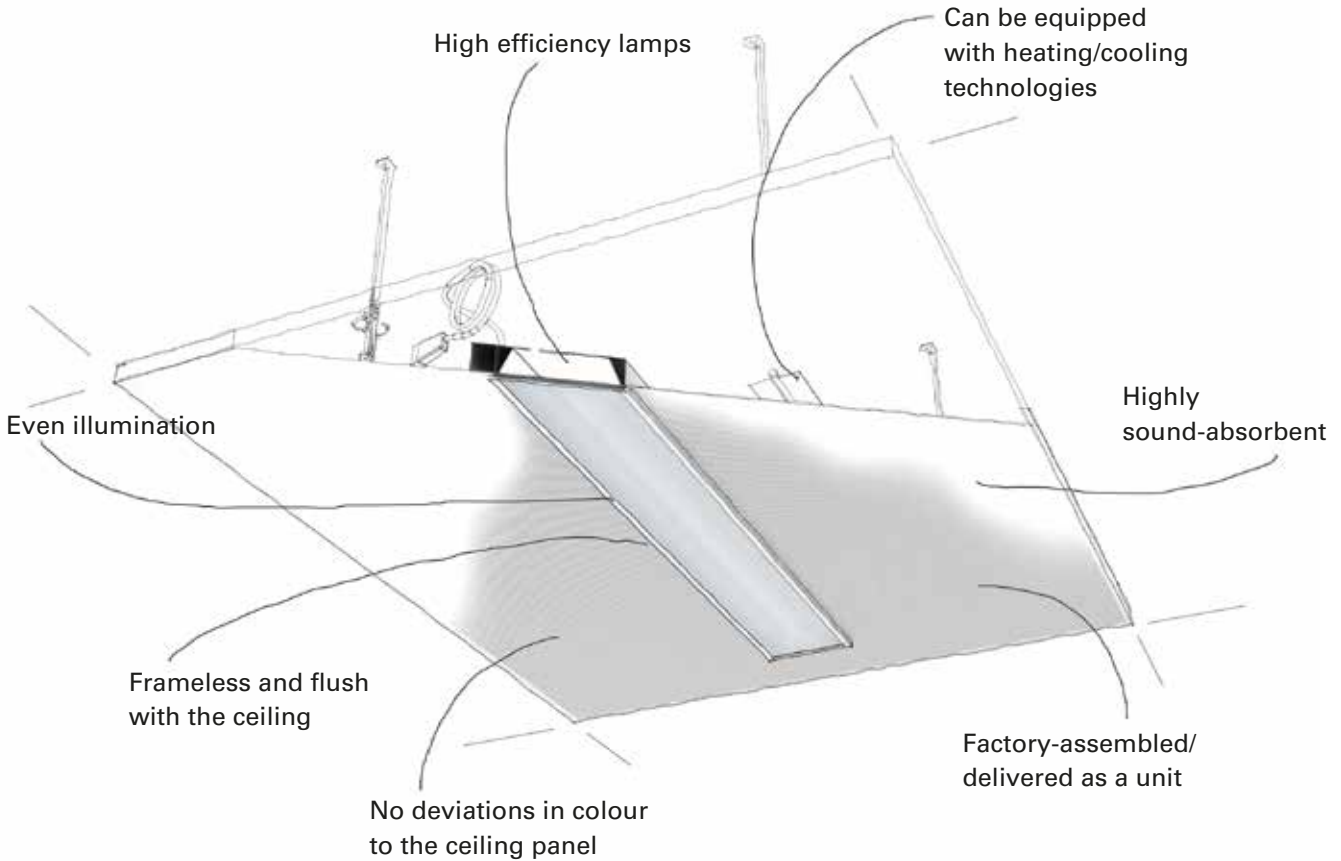

Office building, Moskow, Russia
© Zahar Aborkin

Light Channels

The length and the execution of the light channels can flexibly be adapted to the room geometry. Moreover, they impress from the technology to the easy installation.

Integrated Luminaires

A wide range of integrated luminaires is available. These luminaires are shapely integrated into ceiling panels. Moreover, they are adapted to the room concept and the lighting quality.

System Luminaires

A multitude of system luminaires which are perfectly adapted to the ceiling systems regarding dimensions, installation and colour deviation are available.

Joint Designs

The visual of the ceiling system can be influenced by a selection of different joint designs. Besides aesthetic aspects, the joint design can also have an effect on the acoustic performance. Determine your choice of joint width by ordering panels with different spacers.



Gasket filled joint

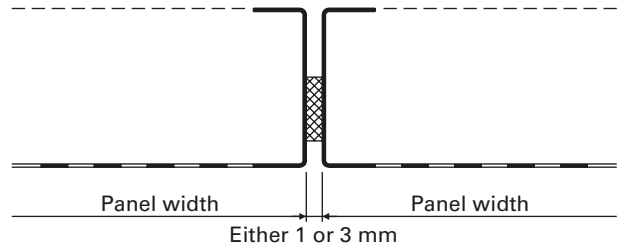

Panel abutment with joint and spacer

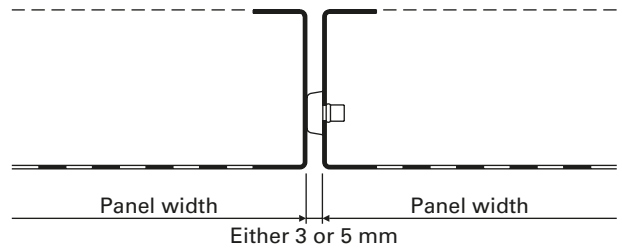

Joint with embossed panel turn-up

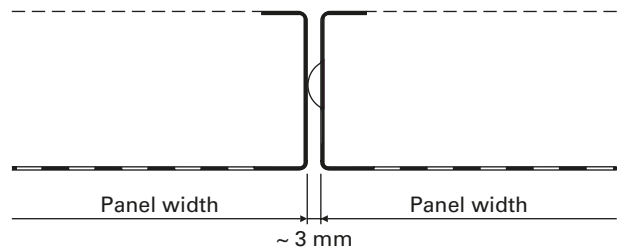

Butt joint

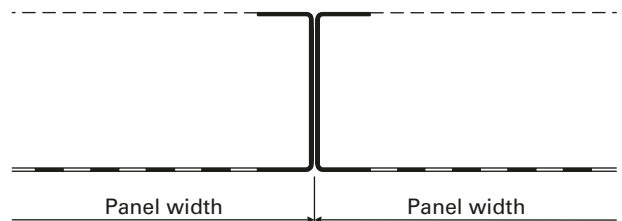

Wall Connections

Wall connections can be realised in different ways – with and without shadow gap. To ensure that cut panels rest entirely on the trim's supporting finish without any corrugation, hold-down clips and sheets are applied. Specially designed trims for columns provide for a clean connection to curved shapes.



L-trim



Shadow gap trim



Pillar semiring



Further wall connections available on request.

Surfaces

Lindner has a wide range of ceiling surfaces for different demands – so that your rooms are not only extraordinary but unique. We apply various colours, patterns, graphics, 3D textures and perforations to your metal ceiling. In particularly challenging areas, we furnish our systems with coatings that are more than just eye-catchers: They create a significant improvement of room quality.



Unilever, Hamburg, Germany



Tsvetnoy Market, Moscow, Russia
© Chris Gascoigne



Dubai Metro Station, UAE



VR-Bank, Heilbronn, Germany
© Volker Erich Jahr

Possible surfaces

- Powder Coating
- Design Surface
 - ARTline – Design Powder Coating
 - GRAPHICline – Print Technology
 - EFFECTline – Grinding Technology
 - SPREADline – Customised, image and scattered perforation
- Functional Surfaces
 - Meteo – Corrosion Coating
 - Mutex – Absorber Coating
- Special Surfaces
 - INOXlook – Aluminium with appearance of stainless steel
- Structured Surfaces
 - TOUCHdesign – 3D Surface
 - TOUCHdesign Lunar – 3D high-gloss Surface
 - TOUCHdesign Venas – 3D Structured Surface
 - TOUCHdesign Viva – 3D Expanded Metal Surface
- Expanded Metal
- Perforations



Green Building

A responsible approach to humans and nature is a matter of course for us as a manufacturer of long lasting ceiling systems in premium quality. We are continuously optimizing our wide range with the objective to further reduce their impact on the environment. Every production step is subject to a thorough control of the ambitious energy, material and quality requirements. This ensures that our clients do not only get a sophisticated product but that they can also rely on the ecological suitability.

Validated environmental product declarations according to ISO 14025 are available for the procedure of proof of the environmental performance of Lindner ceiling systems.



Unilever, Hamburg, Germany



Lindner is a founding member of the German Sustainable Building Council (DGNB) and member of the US Green Building Council. We are actively involved in building up awareness for the principles of sustainable construction and the development of relevant standards.

Sustainable construction with Lindner ceiling systems:

- Extremely durable products with best functional characteristics and high economic efficiency
- End-to-end procedure of proof of the ecological material characteristics by environmental product declarations
- Consultancy service with all current building certifications, as for example according to DGNB, LEED, BREEAM

Simply healthier: Lindner ceiling systems.

- High recycling percentage up to 45 %
- VOC values are considerably below the limit according to AgBB / DIBt
- Free from toxicological gases, thus it is toxicologically inoffensive in case of fire according to DIN 53436
- The substances used for pre-cleaning of powder coating are no hazardous substances according to the Ordinance on Hazardous Substances.
- Powder recovery of surface coating of approx. 25 %
- Reference useful life is 70 years according verified EPD
- Up to 30 % of the primary energy demand can be saved with Plafotherm® heated and chilled ceiling systems

We can do it all for you.

Lindner Concepts:

- Airports and Railways
- Clean Rooms and Operating Theatres
- Cruise Liner and Ship Fit-out
- General Contracting
- Hotels and Resorts
- Insulation and Industrial Service
- Interior Fit-out and Furnishings
- Special-Purpose Constructions and Stadiums
- Studios and Concert Halls
- System Buildings

Lindner Products:

- Ceiling Systems
- Doors
- Dry Lining Systems
- Facades
- Floor Systems
- Heating and Cooling Technologies
- Lights and Lighting Systems
- Partition Systems
- Roofing Systems
- Steel & Glass

Lindner Service:

- Clearance of Harmful Substances
- Construction Management and Project Development
- Deconstruction and Interior Demolition
- General Planning
- Global Product Supplies
- Green Building
- Industrial Scaffolding
- Installation and Building Services
- Research and Development

Lindner Group

Bahnhofstrasse 29
 94424 Arnstorf
 Germany
 Phone +49 8723 20-0
 Fax +49 8723 20-2147
ceilingsystems-ps@Lindner-Group.com
www.Lindner-Group.com